

# FLAT TOP TOWER CRANE



**Specifications:**

- ▶ Max jib length: 65,00 m
- ▶ Capacity at max length: 1,71 t
- ▶ Max capacity: 8,00 t

**WORKS FOR YOU.™**

# KEY

## Legenda · Zeichenerklärung · Légende · Leyenda · Legenda · Условные обозначения



Hoisting · Sollevamento · Heben · Levage · Elevación · Elevação · Подъем



Trolleying · Traslazione carrello · Katzfahren · Distribution · Distribución · Distribuição · Передвижение каретки



Slewing · Rotazione · Schwenken · Orientation · Orientació · Giro · Поворот



Travelling · Traslazione · Schienenfahren · Translation · Traslación · Móvel · Передвижение



Directive on noise level · Direttiva sul livello acustico · Richtlinie für den Schall-Leistungspegel · Directive sur le niveau acoustique · Directiva sobre el nivel acustico · Directiva sobre nivel de ruidos · Директива по уровню шума



Consult us · Consultateci · Auf Anfrage · Nous consulter · Consultarnos · Consulte-nos · Проконсультироваться с нами



Power requirements · Geforderte Stromstärke · Puissance totale nécessaire · Potencia necesaria · Potenza totale richiesta · Requisitos de energia · Требования по питанию



Power supply · Alimentazione · Stromversorgung · Alimentation · Alimentación · Fonte de alimentação · Питание



With Terex Power Match · Con Terex Power Match · Mit Terex Power Match · Avec Terex Power Match · Con Terex Power Match · Com Terex Power Match · с Terex Power Match



In service · In servizio · In Betrieb · En service · En servicio · Em serviço · При работе



Out of service · Fuori servizio · Außer Betrieb · Hors service · Fuera de servicio · Fora de serviço · В режиме простоя



Max. under hook height · Altezza max. sotto gancio · Höchste Hakenhöhe · Hauteur maxi. sous crochet · Maxima altura bajo gancho · Alt. máx. sob o gancho · Макс высота крюка



Without load, without ballast, max. jib and max. height · A vuoto, senza zavorra, braccio max., altezza max. · Ohne Last und Ballast, mit Maximalausleger und Maximalhöhe · A vide, sans lest, avec flèche et hauteur maximum · Sin carga, sin lastre, con pluma y altura máxima · Sem carga, sem lastro, lança máxima, altura máxima · Без груза, без балласта, на макс. Длине вспомогательной стрелы и макс. Высоте



Counterweight · Zavorra controbraccio · Gegengewicht · Lest de contre-flèche · Lastre de contra flecha · Contrapeso · Противовес

**C25**

EN 14439-C25 out of service proof with LC1 & LC3 - wind coming from each side 100 Km/h - For different requirement please contact us · EN 14439 - C25 fuori servizio con LC1 & LC 3 - vento in ogni direzione 100 km/h - contattateci per differenti richieste · EN 14439 - C25 außer Betrieb mit LC1 & LC3 - Wind von jeder Seite 100 km/h - für abweichende Anforderungen kontaktieren Sie uns bitte · EN14439 - C25 hors service avec LC1 & LC3 - vent 100km/h de chaque côté - Nous contacter pour des caractéristiques différentes · EN 14439 - C25 fuera de servicio con LC1 & LC3 - viento de cada lado 100 km/h - contáctenos si necesita más información · EN 14439 - C25 fora de serviço com LC1 e LC3 - vento de cada lado 100 kmh - para pedidos especiais, entre em contato conosco · EN14439 - C25 не совместим с LC1 & LC3 - ветровая нагрузка не более 100км/ч - для уточнения спецификаций обращайтесь, пожалуйста, к нам

# CONTENTS

СТТ 172-8

Indice · Inhalt · Contenu · Contenido · Sumário · Содержание

Page · Pagina · Seite · Page · Página · Página · Страница:

Load Diagram · Diagramma di portata · Lastkurven · Courbes de charges · Curvas de cargas · Diagrama de carga · Диаграмма грузоподъёмности . . . . .	4
Tower · Torre · Turm · Tour · Torre · Torre · Башня . . . . .	8
Mechanisms · Meccanismi · Antriebe · Mécanismes · Mecanismos · Mecanismo · Механизм . . . . .	15
Transportation · Trasporto · Transport · Transport · Transporte · Transporte · Транспортировка . . . . .	17

# LOAD DIAGRAM

Diagramma di portata · Lastkurven · Courbes de charges · Curvas de cargas · Diagrama de carga · Диаграмма грузоподъёмности

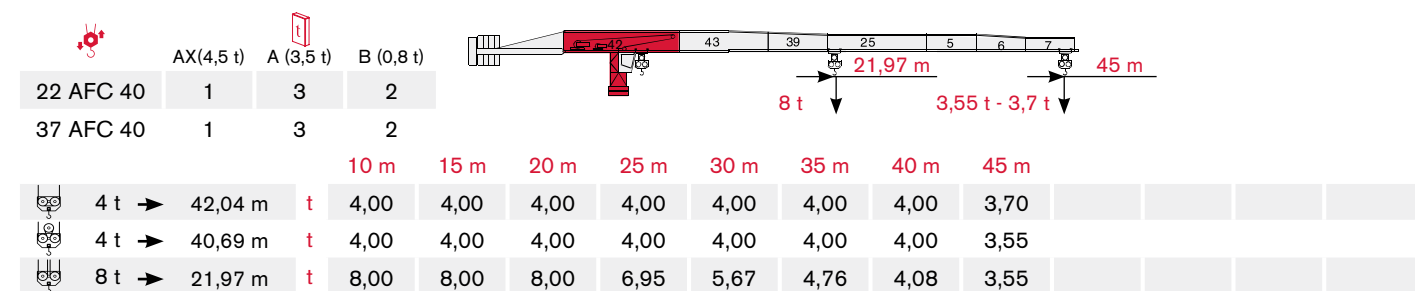
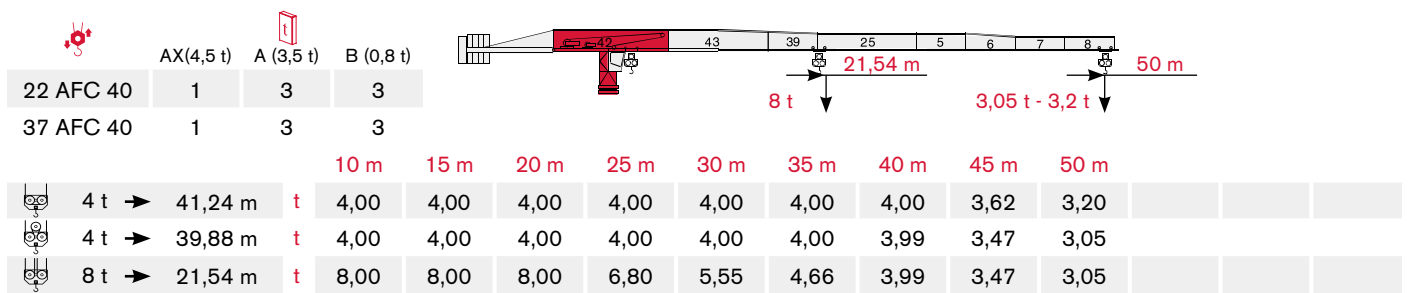
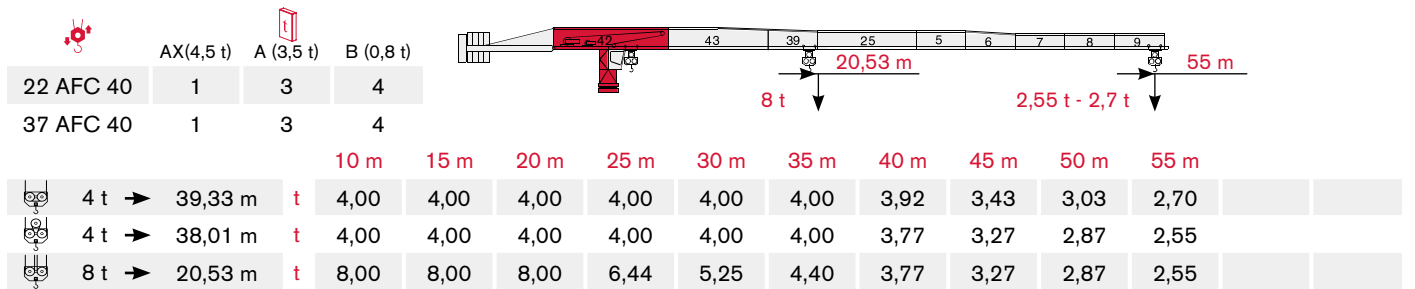
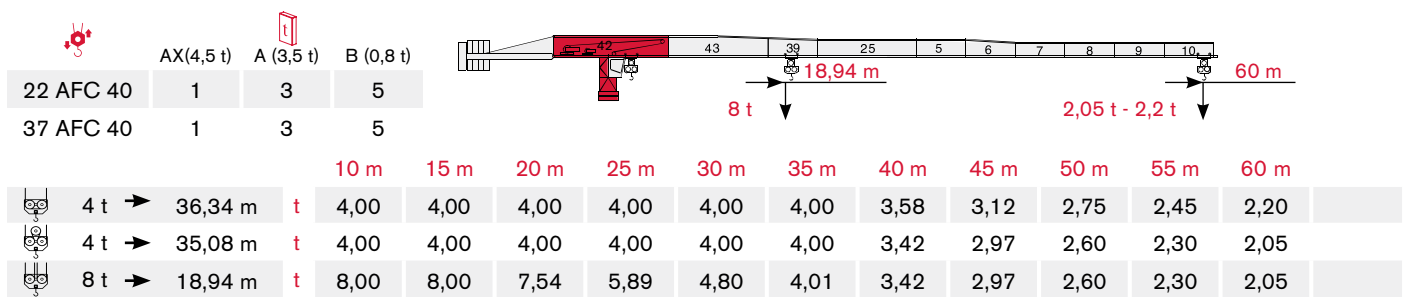
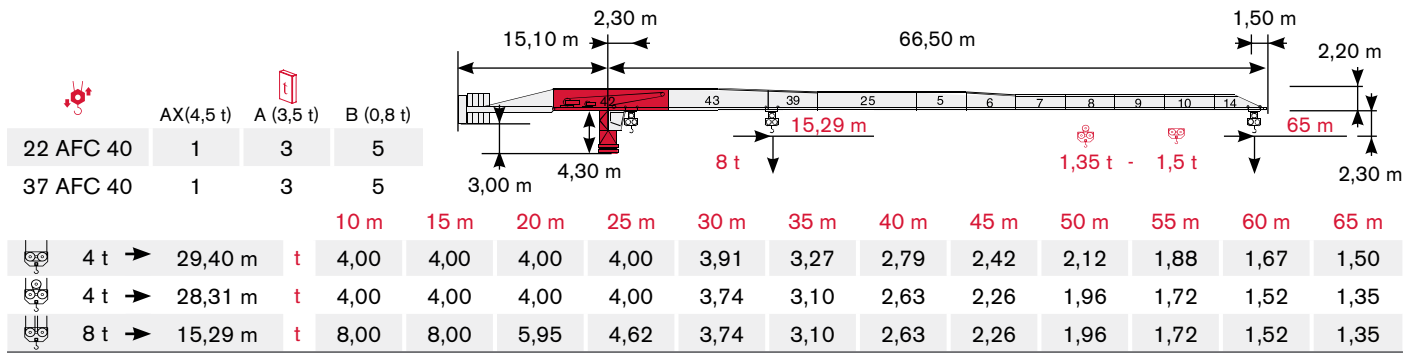

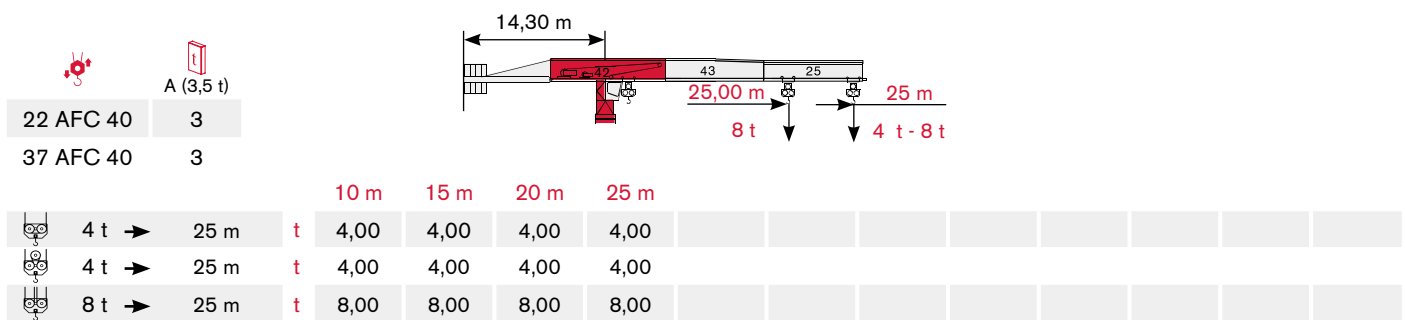
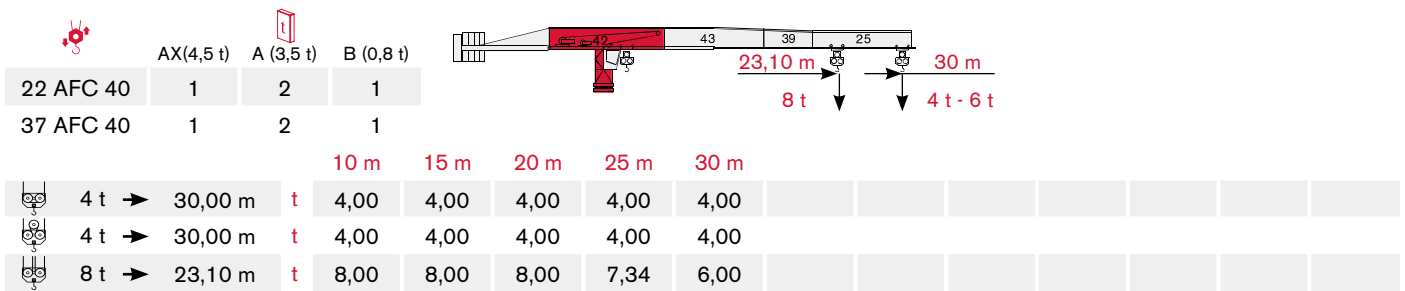
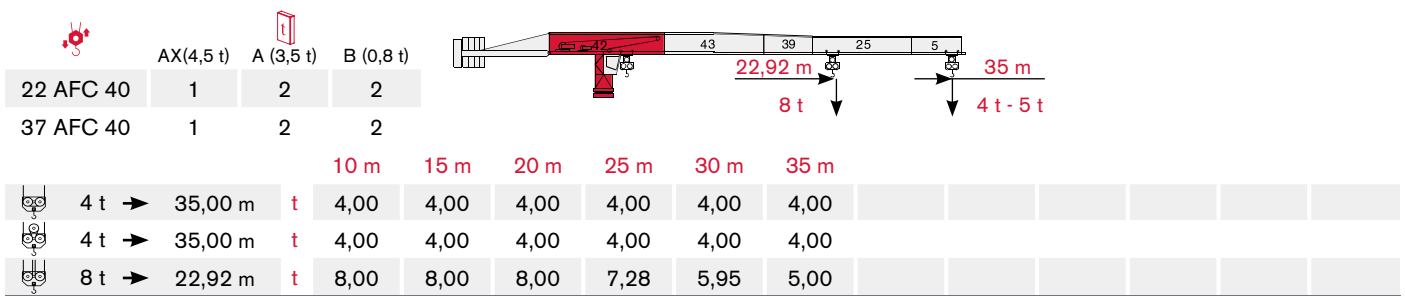
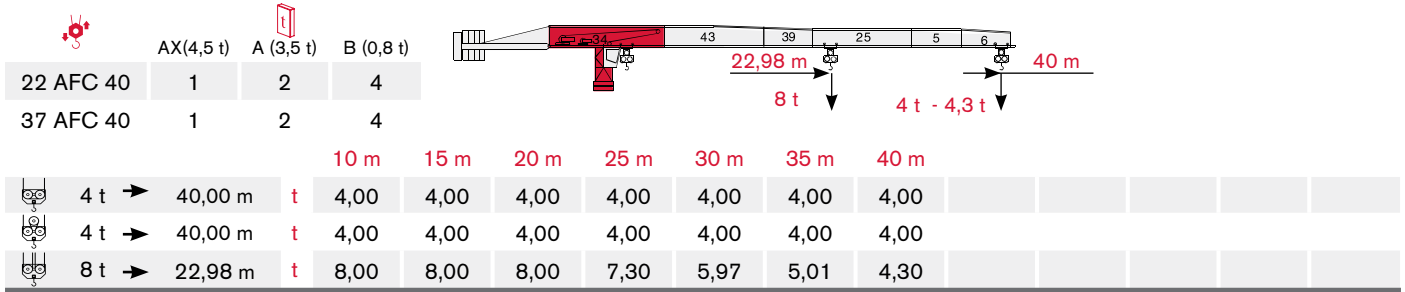

# LOAD DIAGRAM

Diagramma di portata · Lastkurven · Courbes de charges · Curvas de cargas · Diagrama de carga · Диаграмма грузоподъёмности

## TEREX POWER PLUS

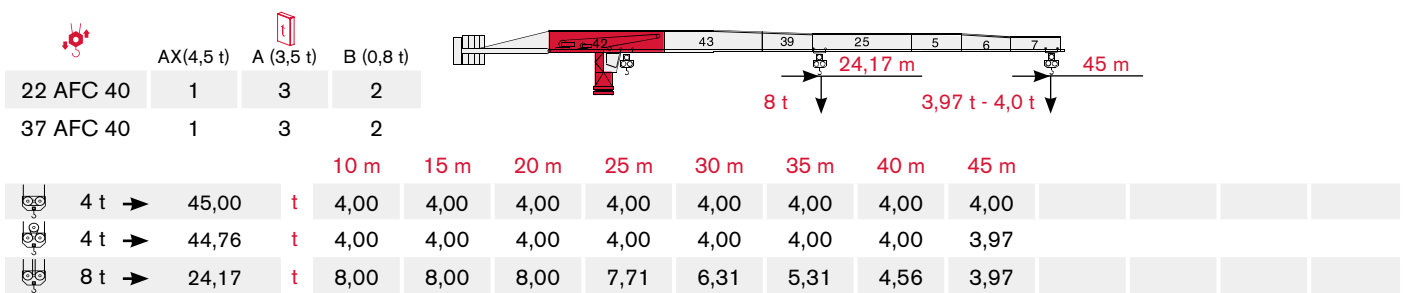
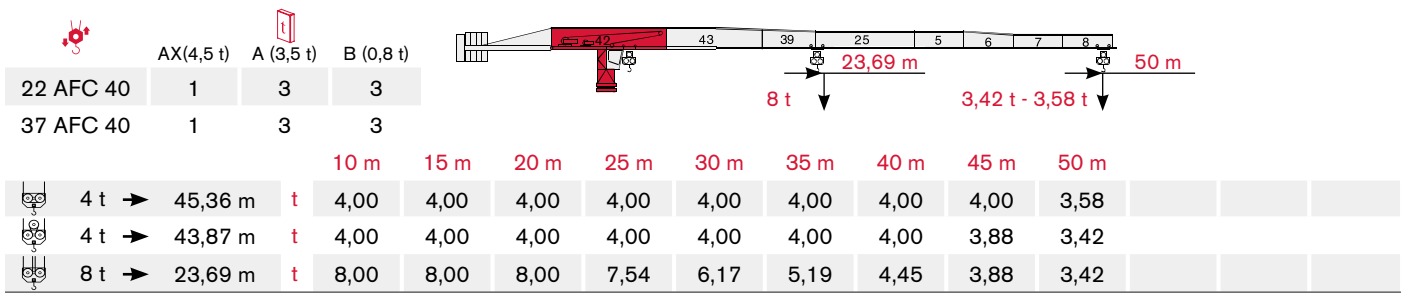
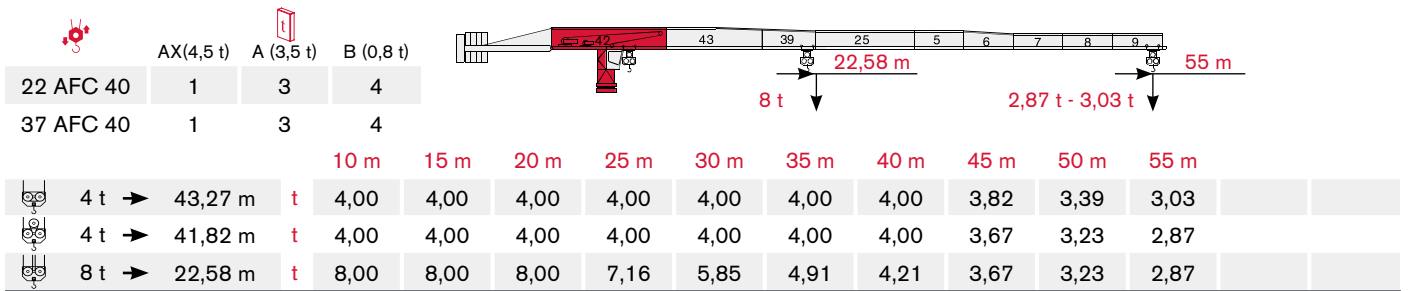
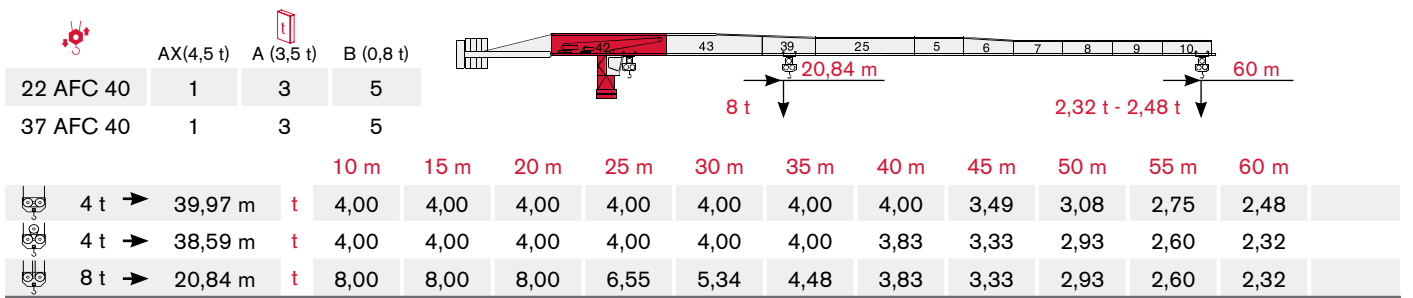
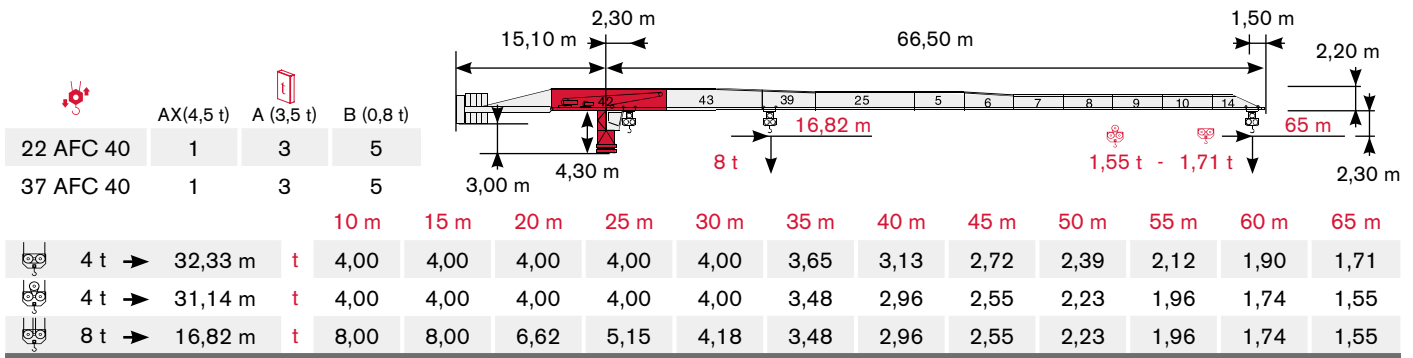

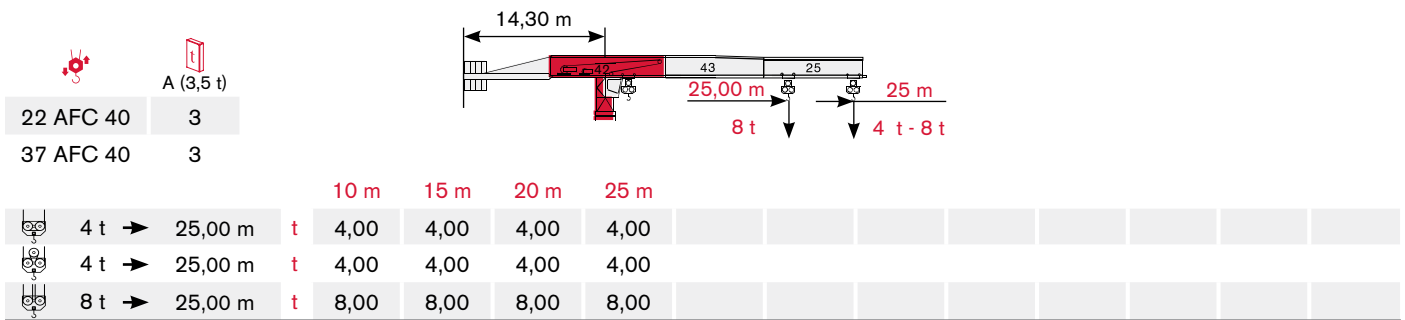
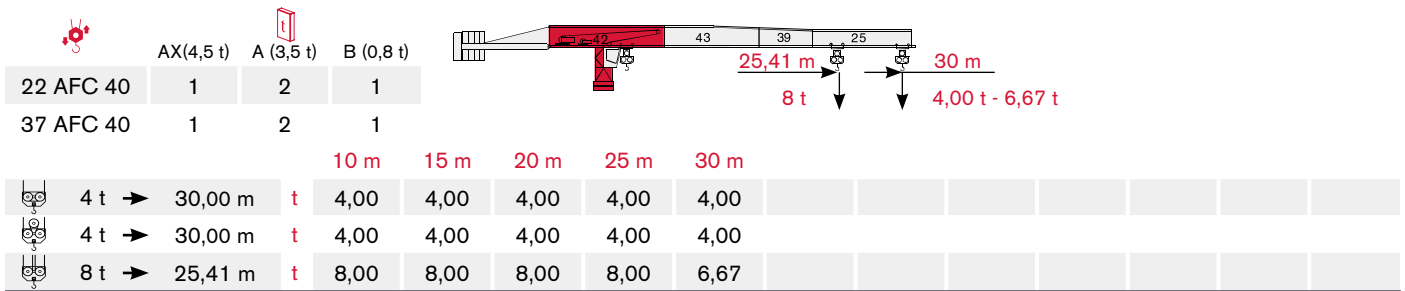
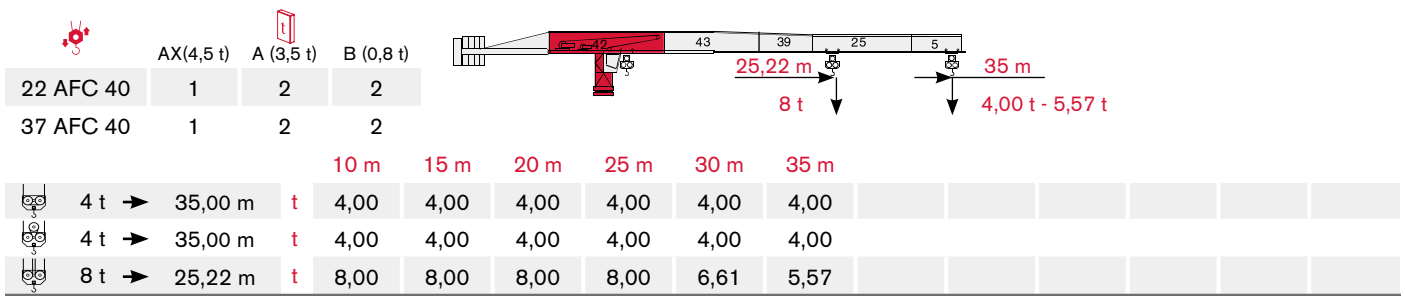
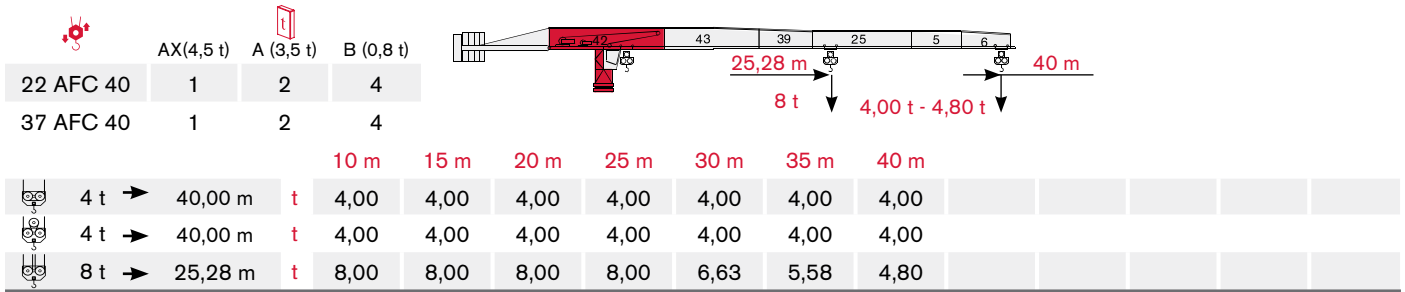

# TOWER

Torre · Turm · Tour · Torre · Torre · Башня

Standard Configurations · Installazioni Standard · Standardkonfiguration · Standard Implantations · Implantaciones Standard · Configuração padrão · Стандартная конфигурация крана

## TS16

Tower: TS16 & Basement: R1

	●	◊
R1	-1760 kN	-2165 kN
R2	1395 kN	1845 kN
	655 kN	

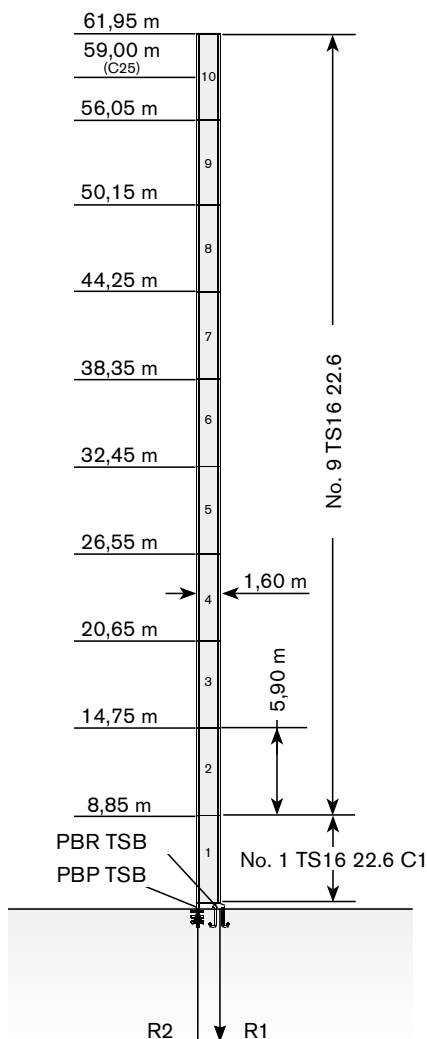

→	max. H (m)	
	FEM 1001	FEM 1005 C25
25-45 m	61,95	59,00
50-65 m	59,00	56,05

Tower: TS16 & Basement: F1

	●	◊
R1	-925 kN	-1070 kN
R2	0 kN	0 kN
	660 kN	

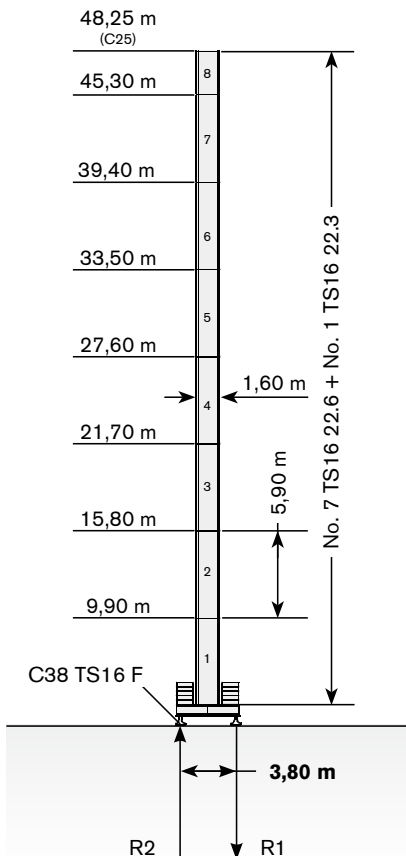

→	max. H (m)	
	FEM 1001	FEM 1005 C25
25-45 m	48,25	48,25
50-65 m	48,25	48,25

Tower: TS16 & Basement: FP1

	●	◊
R1	-995 kN	-1170 kN
R2	0 kN	0 kN
	660 kN	

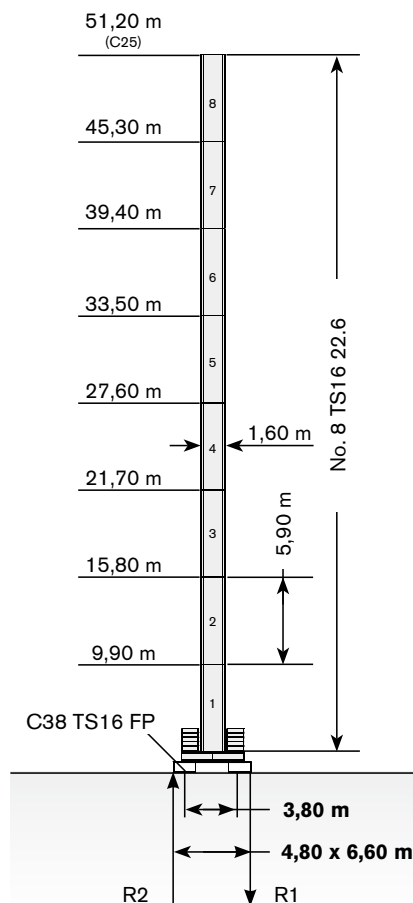

→	max. H (m)	
	FEM 1001	FEM 1005 C25
25-45 m	51,20	51,20
50-65 m	51,20	51,20

Max. under hook height · Altezza max. sotto gancio · Höchste Hakenhöhe · Hauteur maxi. sous crochet · Maxima altura bajo gancho · Alt. máx. sob o gancho · Макс высота крюка

Different heights and tower combinations are available; please consult us · Altezze diverse e combinazioni di torre sono disponibili; consultateci · Andere Höhen und Turmkombinationen auf Anfrage · Différentes hauteurs et combinaisons de tour sont disponibles; nous consulter · Hay diferentes alturas y combinaciones de torre disponibles. Consúltenos · Diferentes alturas e combinações de torres disponíveis; fale conosco · Возможны другие сочетания высоты и конфигурации башни; проконсультируйтесь с нами



Tower: TS16 & Basement: T1

	●	◊
R1	-1025 kN	-1070 kN
R2	0 kN	0 kN
	660 kN	

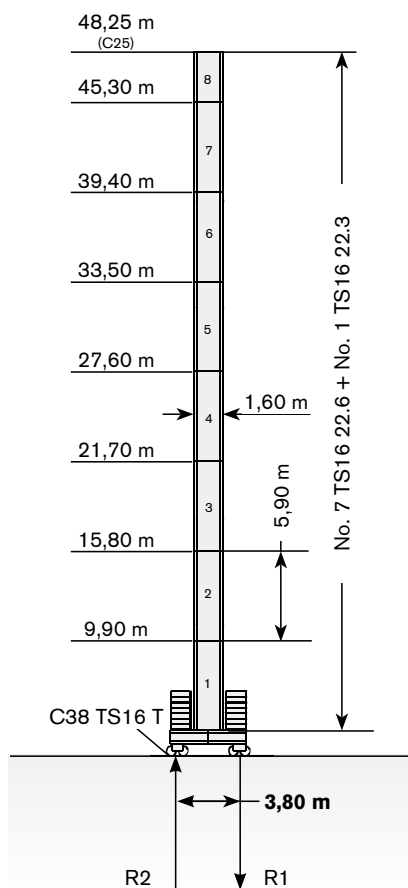

→	max. H (m)	
	FEM 1001	FEM 1005 C25
		
25-45 m	48,25	48,25
50-65 m	48,25	48,25

Tower: TS16 & Basement: F2

	●	◊
R1	-890 kN	-1150 kN
R2	0 kN	0 kN
	690kN	

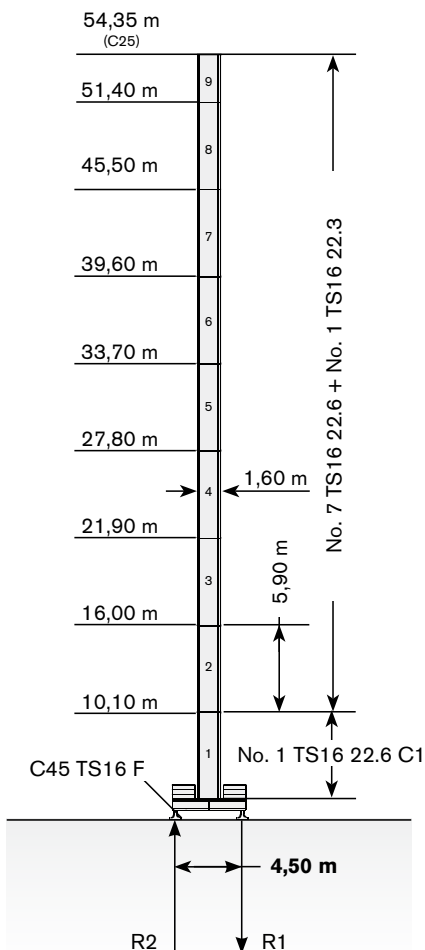

→	max. H (m)	
	FEM 1001	FEM 1005 C25
		
25-45 m	54,35	54,35
50-65 m	54,35	54,35

Tower: TS16 & Basement: FP2

	●	◊
R1	-955 kN	-1155 kN
R2	0 kN	0 kN
	690 kN	

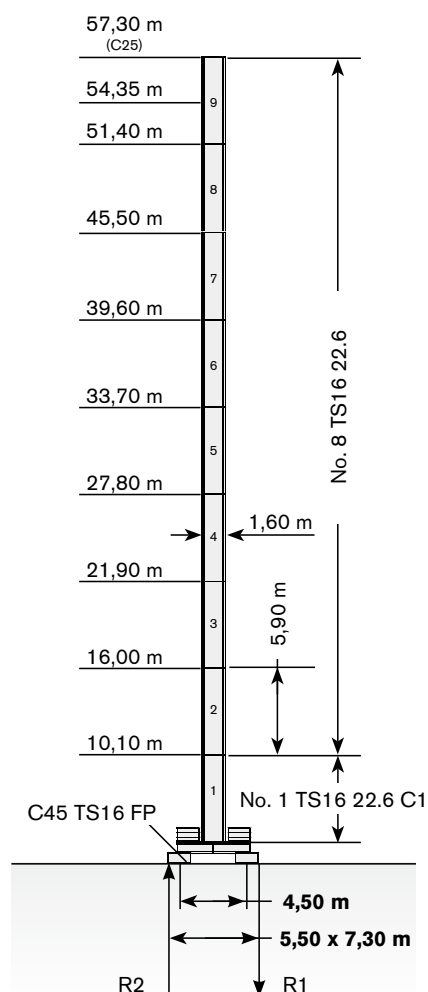

→	max. H (m)	
	FEM 1001	FEM 1005 C25
		
25-45 m	57,30	57,30
50-65 m	57,30	54,35

The available lengths for the TS tower sections are 11.8 m, 5.9 m, 2.95 m. · Le prolunghe TS sono disponibili in lunghezze 11.8 m, 5.9 m, 2.95 m. · Die Turmschüsse TS sind mit Längen 11.8 m, 5.9 m, 2.95 m verfügbar. · Les éléments de mât TS sont disponibles en longueur 11.8 m, 5.9 m, 2.95 m. · Los tramos de torre TS son disponibles en las medidas de largo 11.8 m, 5.9 m, 2.95 m. · Os comprimentos disponíveis para elementos de torre TS são: 11.8m, 5.9m e 2.95m. · Длина поставляемых секций башни TS - 11.8 м, 5.9 м, 2.95 м.

# TOWER

Torre · Turm · Tour · Torre · Torre · Башня

Standard Configurations · Installazioni Standard · Standardkonfiguration · Standard Implantations · Implantaciones Standard · Configuração padrão · Стандартная конфигурация крана

## TS16

Tower: TS16 & Basement: T2

	●	◊
R1	-980 kN	-1150 kN
R2	0 kN	0 kN
	690 kN	

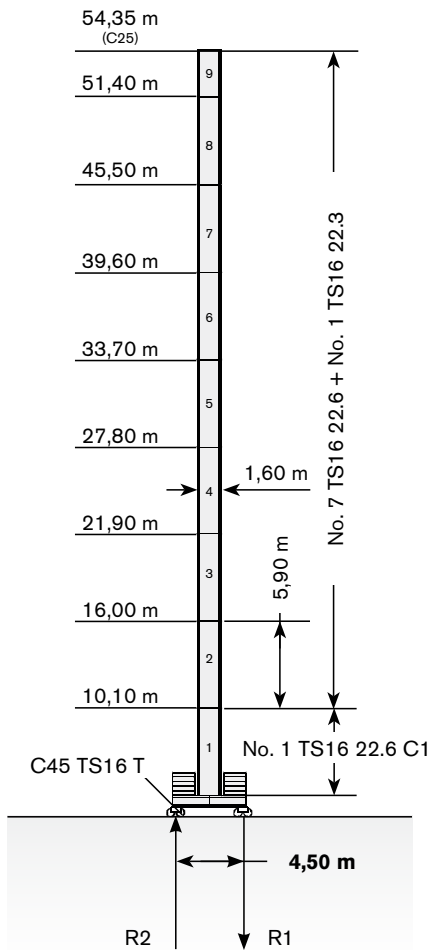

→	max. H (m)	
	FEM 1001	FEM 1005 C25
		
25-45 m	54,35	54,35
50-65 m	54,35	54,35

Max. under hook height · Altezza max. sotto gancio · Höchste Hakenhöhe · Hauteur maxi. sous crochet · Maxima altura bajo gancho · Alt. máx. sob o gancho · Макс высота крюка

Different heights and tower combinations are available; please consult us · Altezze diverse e combinazioni di torre sono disponibili; consultateci · Andere Höhen und Turmkombinationen auf Anfrage · Différentes hauteurs et combinaisons de tour sont disponibles; nous consulter · Hay diferentes alturas y combinaciones de torre disponibles. Consultémos · Diferentes alturas e combinações de torres disponíveis; fale conosco · Возможны другие сочетания высоты и конфигурации башни; проконсультируйтесь с нами

## TS21

Tower: TS21 & Basement: R2

R1	-1445 kN	-2180 kN
R2	1040 kN	1815 kN
	730 kN	

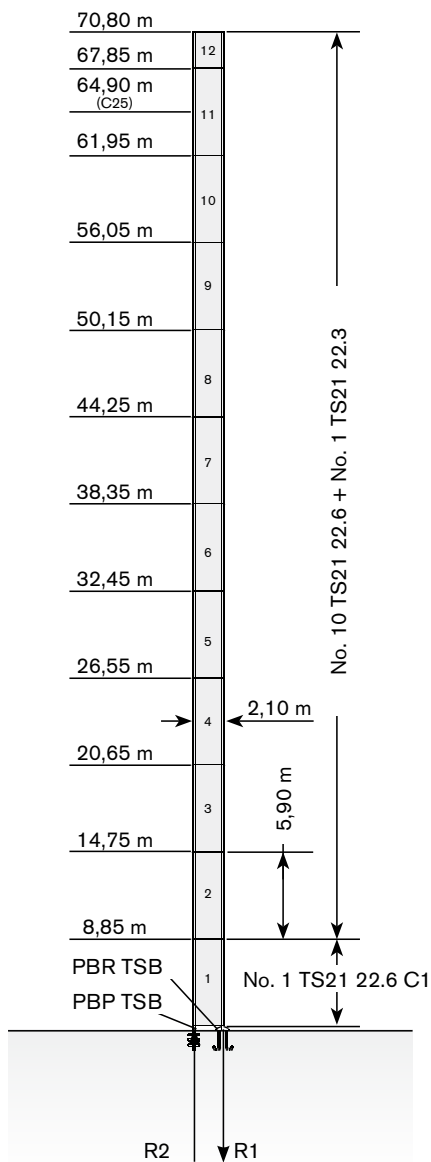

→	max. H (m)	
	FEM 1001	FEM 1005 C25
25-45 m	70,80	64,90
50-65 m	67,80	61,95

Tower: TS21 & Basement: F3

R1	-860 kN	-1035 kN
R2	0 kN	0 kN
	710 kN	

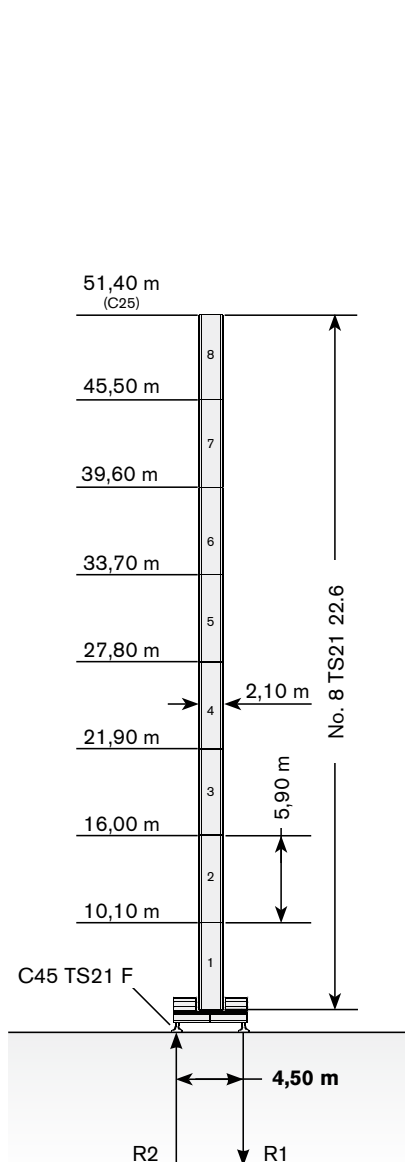

→	max. H (m)	
	FEM 1001	FEM 1005 C25
25-45 m	51,40	51,40
50-65 m	51,40	51,40

Tower: TS21 & Basement: FP3

R1	-940 kN	-1180 kN
R2	0	0
	740 kN	

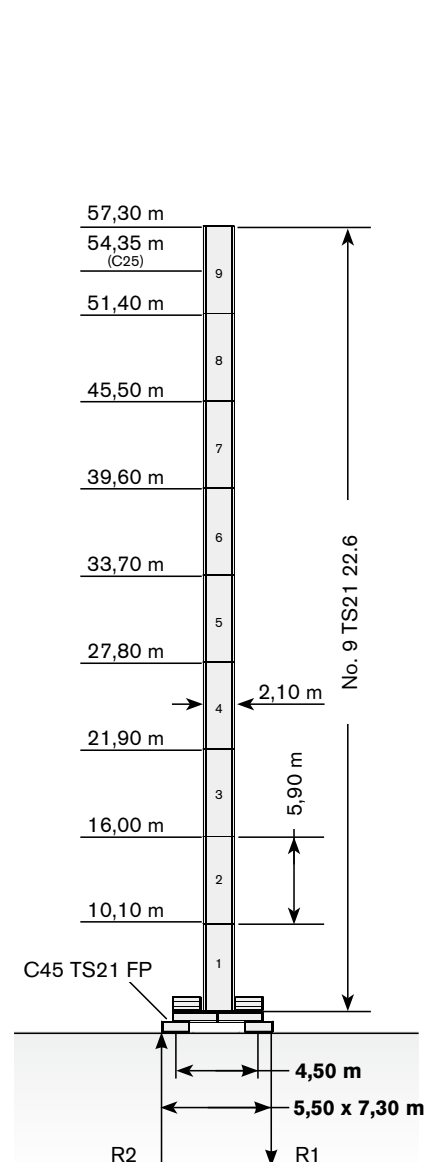

→	max. H (m)	
	FEM 1001	FEM 1005 C25
25-45 m	57,30	54,35
50-65 m	57,30	54,35

The available lengths for the TS tower sections are 11.8 m, 5.9 m, 2.95 m. · Le prolonghe TS sono disponibili in lunghezze 11.8 m, 5.9 m, 2.95 m. · Die Turmschüsse TS sind mit Längen 11.8 m, 5.9 m, 2.95 m verfügbar. · Les éléments de mât TS sont disponibles en longueur 11.8 m, 5.9 m, 2.95 m. · Los tramos de torre TS son disponibles en las medidas de largo 11.8 m, 5.9 m, 2.95 m. · Os comprimentos disponíveis para elementos de torre TS são: 11.8m, 5.9m e 2.95m. · Длина поставляемых секций башни TS - 11.8 м, 5.9 м, 2.95 м.

# TOWER

Torre · Turm · Tour · Torre · Torre · Башня

Standard Configurations · Installazioni Standard · Standardkonfiguration · Standard Implantations · Implantaciones Standard · Configuração padrão · Стандартная конфигурация крана

## TS21

Tower: TS21 & Basement: T3

R1	-920 kN	-1035 kN
R2	0 kN	0 kN
	710 kN	

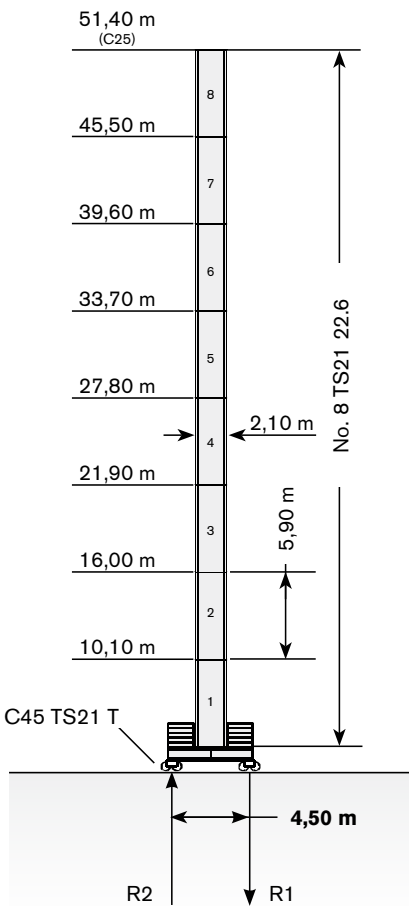

→	max. H (m)	
	FEM 1001	FEM 1005 C25
25-45 m	51,40	51,40
50-65 m	51,40	51,40

Tower: TS21 & Basement: F4

R1	-805 kN	-1085 kN
R2	0 kN	0 kN
	790 kN	

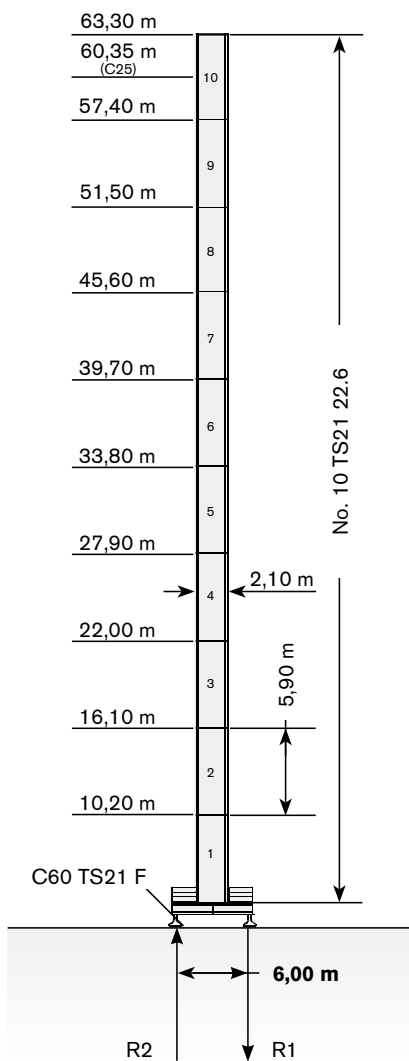

→	max. H (m)	
	FEM 1001	FEM 1005 C25
25-45 m	63,30	60,35
50-65 m	63,30	57,40

Tower: TS21 & Basement: FP4

R1	-890 kN	-1195 kN
R2	0 kN	0 kN
	805 kN	

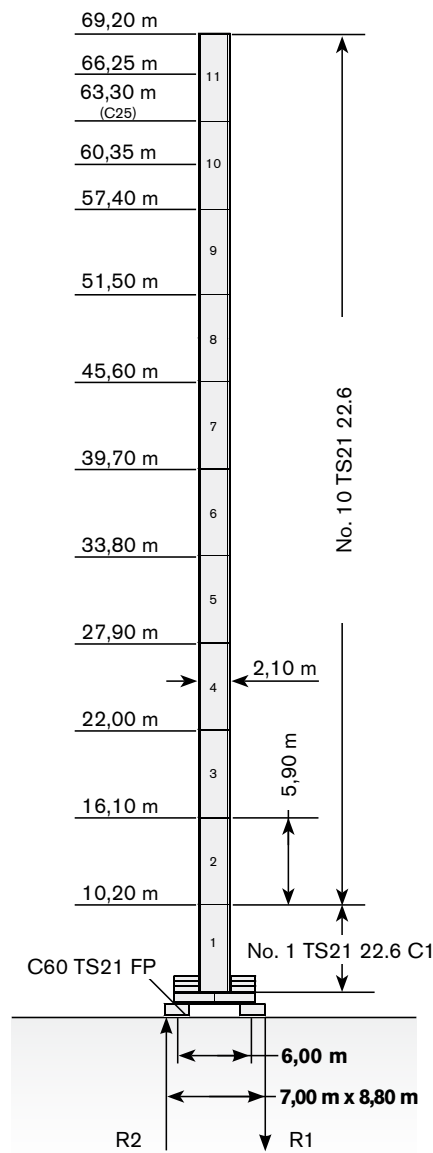

→	max. H (m)	
	FEM 1001	FEM 1005 C25
25-45 m	69,20	63,30
50-65 m	66,25	60,35

Max. under hook height · Altezza max. sotto gancio · Höchste Hakenhöhe · Hauteur maxi. sous crochet · Maxima altura bajo gancho · Alt. máx. sob o gancho · Макс высота крюка

Different heights and tower combinations are available; please consult us · Altezze diverse e combinazioni di torre sono disponibili; consultateci · Andere Höhen und Turmkombinationen auf Anfrage · Différentes hauteurs et combinaisons de tour sont disponibles; nous consulter · Hay diferentes alturas y combinaciones de torre disponibles. Consultémos · Diferentes alturas e combinações de torres disponíveis; fale conosco · Возможны другие сочетания высоты и конфигурации башни; проконсультируйтесь с нами



Tower: TS21 & Basement: T4

	●	◊
R1	-870 kN	-1085 kN
R2	0 kN	0 kN
	790 kN	

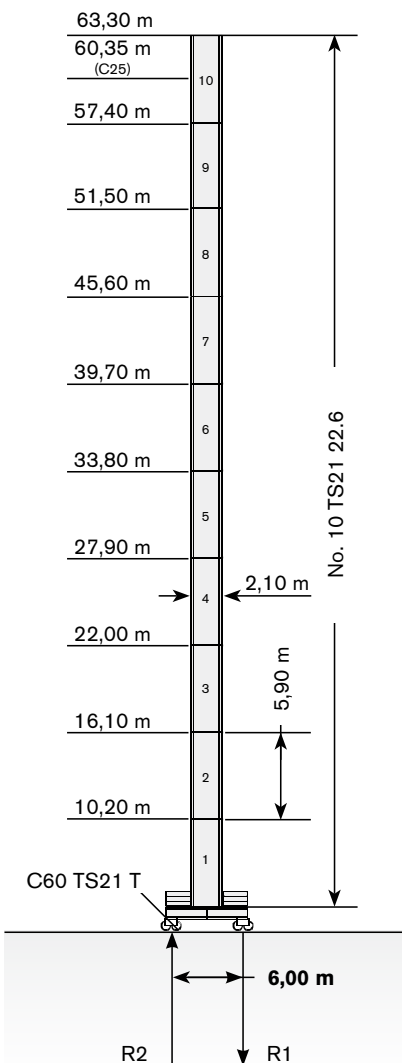

→	max. H (m)	
	FEM 1001	FEM 1005 C25
		
25-45 m	63,30	60,35
50-65 m	63,30	57,40

The available lengths for the TS tower sections are 11.8 m, 5.9 m, 2.95 m. · Le prolonghe TS sono disponibili in lunghezze 11.8 m, 5.9 m, 2.95 m. · Die Turmschüsse TS sind mit Längen 11.8 m, 5.9 m, 2.95 m verfügbar. · Les éléments de mât TS sont disponibles en longueur 11.8 m, 5.9 m, 2.95 m. · Los tramos de torre TS son disponibles en las medidas de largo 11.8 m, 5.9 m, 2.95 m. · Os comprimentos disponíveis para elementos de torre TS são: 11.8m, 5.9m e 2.95m. · Длина поставляемых секций башни TS - 11.8 м, 5.9 м, 2.95 м.

# TOWER

Torre · Turm · Tour · Torre · Torre · Башня

## Other configurations · Altre Installazioni · Aufstellmöglichkeiten · Autres Implantations · Otras Implantaciones · Outras configurações · Другие конфигурации

Bottom climbing crane · Gru climbing · Kletterkran im Gebäude · Télescope sur dalles · Telescopia grúa trepadora · Guindaste automontante interno · Самоподъемный кран

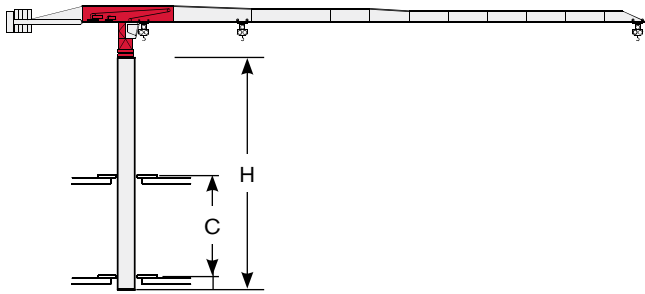

Tower: TS16		
Jib	C min/max (m)	H min/max (m)
25 - 55	11,00/13,00	29,50/44,25
60 - 65	11,00/13,00	29,50/41,30

Tower: TS21		
Jib	C min/max (m)	H min/max (m)
25 - 65	11,00/14,00	29,50/41,30

Crane tied to the structure · Gru ancorata · Geankerter Kran · Grue ancrée · Grúa anclada · Guindaste ancorado na estrutura · Кран, крепящийся к сооружению

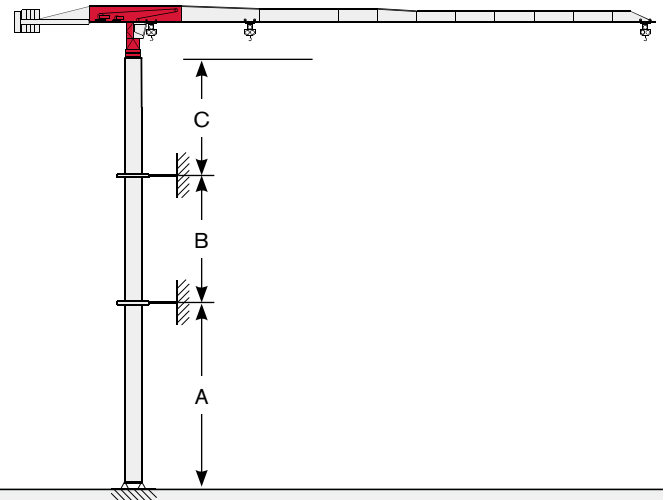

Tower: TS16 - H 200m (C25)			
Jib	A min/max (m)	B min/max (m)	C max (m)
25 - 65	40/47	17,7/23,6	24

Tower: TS21 - H 100m (C25)			
Jib	A min/max (m)	B min/max (m)	C max (m)
25 - 65	38/50	17,7/23,6	35





Tower: TS21 - H 200m (C25)			
Jib	A min/max (m)	B min/max (m)	C max (m)
25 - 65	38/50	17,7/23,6	32

# MECHANISMS

CTT 172-8









Meccanismi · Antriebe · Mécanismes · Mecanismos · Mecanismo · Механизм

Power supply · Alimentazione · Stromversorgung · Alimentation · Suministro eléctrico · Requisitos de energia · Требования по питанию

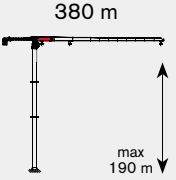
				
	22 AFC 40	46 → 25 kVA*	400V - 50Hz / 460V - 60Hz	2000/14/CE modificata
	37 AFC 40	60 → 36 kVA*	400V - 50Hz / 460V - 60Hz	2000/14/CE modificata

 \* - kVA \*

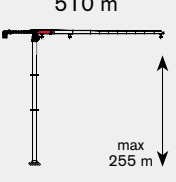
Hoisting · Sollevamento · Heben · Levage · Elevación · Elevação · Подъем

			t	m/min	kW	
	22 AFC 40		4	0 → 27	22	 380 m max 190 m
			3	0 → 35		
			2	0 → 51		
			1,5	0 → 65		
			1	0 → 78		
			8	0 → 14		
			6	0 → 18		
			4	0 → 26		
			3	0 → 34		
			2,5	0 → 39		
	37 AFC 40		4	0 → 44	37	 510 m max 255 m
			3	0 → 57		
			2	0 → 82		
			1,5	0 → 105		
			1	0 → 132		
			8	0 → 22		
			6	0 → 28		
			4	0 → 41		
			3	0 → 52		
			2	0 → 66		

# MECHANISMS

Meccanismi · Antriebe · Mécanismes · Mecanismos · Mecanismo · Механизм

Hoisting Speed · Velocità di Sollevamento · Heben Geschwindigkeit · Vitesse de Levage · Velocidad de Elevación · Velocidade de içamento · Скорость подъема

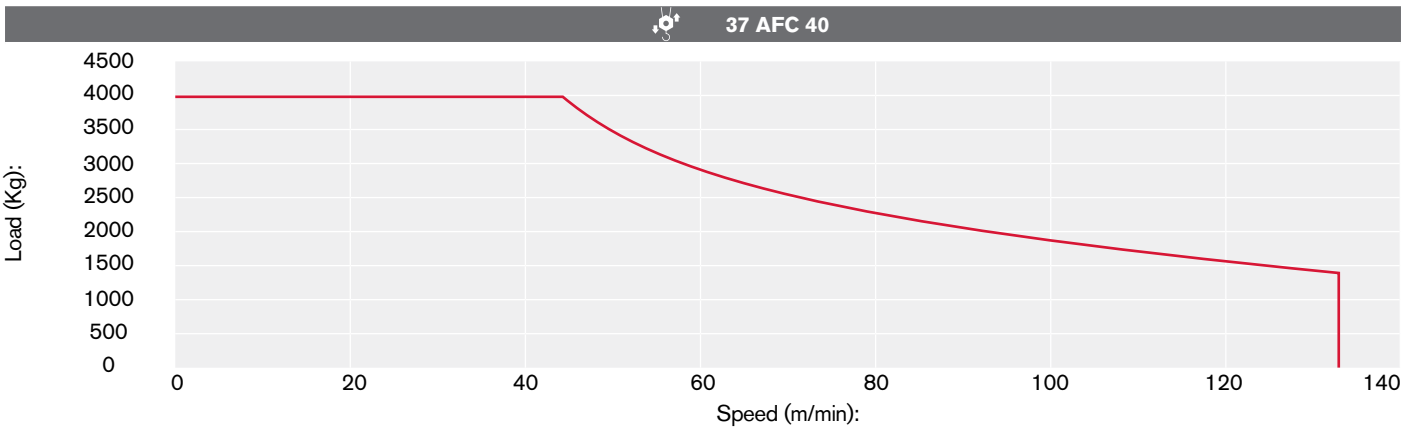
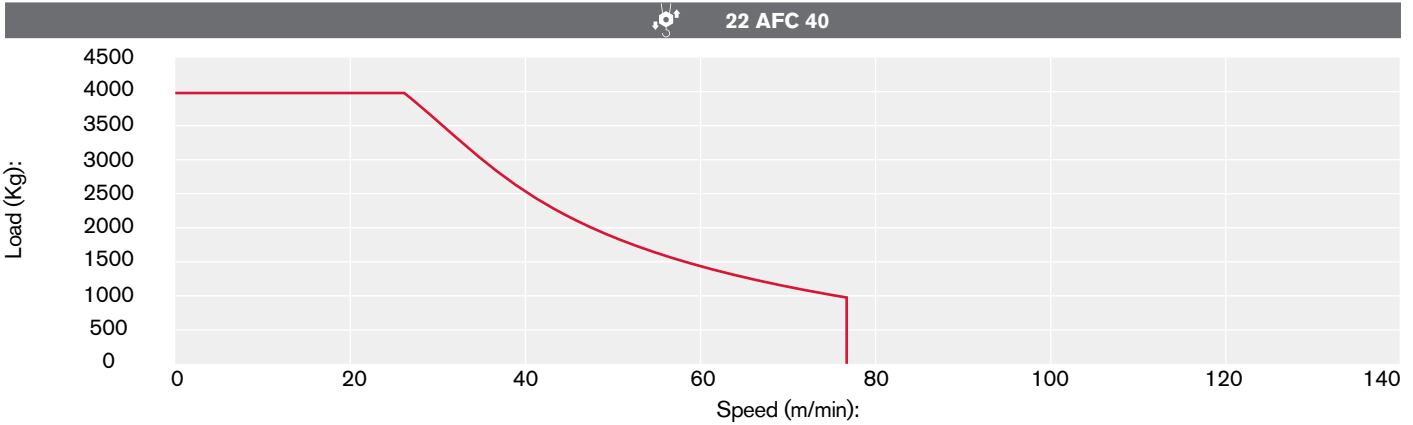

Additional Specifications · Altre movimentazioni · Weitere Leistungsdaten · Spécifications additionnelles · Otras prestaciones · Especificações adicionais · Дополнительные спецификации

	DVF 3 6	0 → 40 → 80 m/min	5,5 kW
	SVF 2 2 6	0.7 r.p.m	2 x 5.5 kW
	TAD 2RP 2M4	0 → 24 m/min	2 x 4 kW
	TAD 2RG 4M3	0 → 24 m/min	4 x 3 kW
	<b>i</b>		







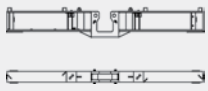

Tower height max.

		T2	T3	T4
	TAD 2RP 2M4	39,60 m	39,60 m	39,70 m
	TAD 2RG 4M3	> 39,60 m	> 39,60 m	> 39,70m

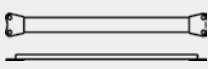

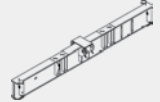
## Packing list

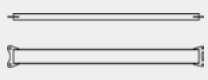
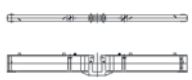









### Undercarriage

CTT 172-8	DESCRIPTION · DESCRIZIONE · BESCHREIBUNG · DESCRIPTION · DESCRIPCIÓN · DESCRIÇÃO · ОПИСАНИЕ	LENGTH · LUNGHEZZA · LÄNGE · LONGUEUR · LONGITUD · COMPRIMENTO · ДЛИНА	WIDTH · LARGHEZZA · BREITE · LARGEUR · ANCHURA · LARGURA · ШИРИНА	HEIGHT · ALTEZZA · HÖHE · HAUTEUR · ALTURA · ALTURA · ВЫСОТА	QUANTITY · QUANTITÀ · MENGE · QUANTITÉ · CANTIDAD · QUANTIDADE · КОЛИЧЕСТВО	WEIGHT · PESO · GEWICHT · POIDS · PESO · ПЕСО · ВЕС
	"A" BEAM FOR C38 UNDERCARRIAGE TS16	5,80 m	0,41 m	0,80 m	1	2050 kg
	"B" BEAM FOR C38 UNDERCARRIAGE TS16	5,80 m	0,75 m	0,70 m	1	2050 kg
	CROSSBEAM FOR C38 UNDERCARRIAGE	3,70 m	0,11 m	0,40 m	2	190 kg
	BEAM "A" FOR UNDERCARRIAGE C45 TS21-TS16	6,80 m	0,40 m	1,00 m	1	2820 kg
	BEAM "B" FOR UNDERCARRIAGE C45 TS21-TS16	6,80 m	0,75 m	0,80 m	1	2620 kg
	CROSSBEAMS UNDERCARRIAGE C45 TS21-TS16	4,40 m	0,12 m	0,54 m	2	230 kg
	CROSSBEAM FOR UNDERCARRIAGE C60	5,90 m	0,60 m	0,20 m	2	450 kg
	"A" BEAM FOR UNDERCARRIAGE C60	8,90 m	0,40 m	1,10 m	1	3600 kg
	"B" BEAM FOR UNDERCARRIAGE C60	8,90 m	0,70 m	0,90 m	1	3600 kg

# TRANSPORTATION

Trasporto · Transport · Transport · Transporte · Transporte · Транспортировка

## Tower

CTT 172-8	DESCRIPTION · DESCRIZIONE · BESCHREIBUNG · DESCRIPTION · DESCRIPCIÓN · DESCRIÇÃO · ОПИСАНИЕ	LENGTH · LUNGHEZZA · LÄNGE · LONGUEUR · LONGITUD · COMPRIENTO · ДЛИНА	WIDTH · LARGHEZZA · BREITE · LARGEUR · ANCHURA · LARGURA · ШИРИНА	HEIGHT · ALTEZZA · HÖHE · HAUTEUR · ALTURA · ALTURA · ВЫСОТА	QUANTITY · QUANTITÀ · MENGE · QUANTITÉ · CANTIDAD · QUANTIDADE · КОЛИЧЕСТВО	WEIGHT · PESO · GEWICHT · PESO · POIDS · PESO · PESO · ВЕС
	TS16 22.3 TOWER SECTION	1,60 m	1,60 m	2,98 m	1	1215 kg*
	TS16 22.6 TOWER SECTION	1,60 m	1,60 m	5,93 m	1	2260 kg*
	TS16 22.12 TOWER SECTION	1,60 m	1,60 m	11,83 m	1	4400 kg*
	TS21 22.6 TOWER SECTION	2,10 m	2,10 m	5,93 m	1	2550 kg*
	TS21 22.6 C1 TOWER SECTION	2,10 m	2,10 m	5,93 m	1	2800 kg*
	TS21 22.6 C2 TOWER SECTION	2,10 m	2,10 m	5,93 m	1	2611 kg*
	TS21 22.3 TOWER SECTION	2,10 m	2,10 m	2,98 m	1	1382 kg*
	TS21 22.12 TOWER SECTION	2,07 m	2,10 m	11,80 m	1	4825 kg
	SLEWING UNIT TS16	2,00 m	2,00 m	1,57 m	1	4050 kg
	SLEWING UNIT TS21	2,21 m	2,49 m	1,63 m	1	4300 kg

\* inclusive of ladders, platforms and assembly equipment

## Cab

CTT 172-8	DESCRIPTION · DESCRIZIONE · BESCHREIBUNG · DESCRIPTION · DESCRIPCIÓN · DESCRIÇÃO · ОПИСАНИЕ	LENGTH · LUNGHEZZA · LÄNGE · LONGUEUR · LONGITUD · COMPRIMENTO · ДЛИНА	WIDTH · LARGHEZZA · BREITE · LARGEUR · ANCHURA · LARGURA · ШИРИНА	HEIGHT · ALTEZZA · HÖHE · HAUTEUR · ALTURA · ALTURA · · ВЫСОТА	QUANTITY · QUANTITÀ · MENGE · QUANTITÉ · · CANTIDAD · QUANTIDADE · КОЛИЧЕСТВО	WEIGHT · PESO · GEWICHT · PESO · POIDS · PESO · PESO · ВЕС
	CAB UNIT PLATFORM	3,35 m	1,77 m	2,43 m	1	1250 kg
	CAB SECTION	1,79 m	1,36 m	3,54 m	1	1500 kg

## Upper Part









	QEG GENERAL ELECTRICAL BOX PLATFORM	2,38 m	1,57 m	1,78 m	1	770 kg
	COUNTERJIB	8,9 m	1,25 m	0,7 m	1	1740 kg
	COUNTERJIB BALLAST BASKET	2,7 m	1,2 m	0,8 m	1	265 kg
	"AX" BALLAST	3 m	1 m	0,6 m	1	4500 kg
	"A" BALLAST	3 m	1 m	0,6 m	1	3500 kg
	"B" BALLAST	1 m	0,53 m	0,63 m	1	800 kg
	JIB SECTION-42 FOR 22 KW HOIST WINCH	11,9 m	1,77 m	2,33 m	1	5450 kg
	JIB SECTION-44 FOR 37 KW HOIST WINCH	11,9 m	1,77 m	2,33 m	1	5450 kg
	JIB SECTION-43	10,3 m	1,11 m	2,30m	1	2050 kg
	JIB SECTION-39	5,30 m	1,11 m	2,20 m	1	1010 kg
	JIB SECTION-25	10,3 m	1,11 m	1,80 m	1	1390 kg

\*Inclusive of ladder, ladder support and protection, platform

# TRANSPORTATION

Trasporto · Transport · Transport · Transporte · Transporte · Транспортировка

## Upper Part

CTT 172-8	DESCRIPTION · DESCRIZIONE · BESCHREIBUNG · DESCRIPTION · DESCRIPCIÓN · DESCRIÇÃO · ОПИСАНИЕ	LENGTH · LUNGHEZZA · LÄNGE · LONGUEUR · LONGITUD · COMPRIENTO · ДЛИНА	WIDTH · LARGHEZZA · BREITE · LARGEUR · ANCHURA · LARGURA · ШИРИНА	HEIGHT · ALTEZZA · HÖHE · HAUTEUR · ALTURA · ALTURA · ВЫСОТА	QUANTITY · QUANTITÀ · MENGE · QUANTITÉ · CANTIDAD · QUANTIDADE · КОЛИЧЕСТВО	WEIGHT · PESO · GEWICHT · PESO · POIDS · PESO · PESO · ВЕС
	JIB SECTION-05	5,20 m	1,11 m	1,80 m	1	530 kg
	JIB SECTION-06	5,2 m	1,11 m	1,80 m	1	510 kg
	JIB SECTION-07	5,20 m	1,11 m	1,3 m	1	450 kg
	JIB SECTION-08	5,20 m	1,11 m	1,3 m	1	430 kg
	JIB SECTION-09	5,20 m	1,11 m	1,3 m	1	300 kg
	JIB SECTION-10	5,20 m	1,11 m	1,30 m	1	285 kg
	JIB SECTION-14	5,20 m	1,11 m	1,30 m	1	225 kg
	JIB POINT	1,3 m	0,8 m	1,1m	1	70 kg
	JIB TROLLEY AND HOIST BLOCKS	1,35 m	1,6 m	0,9 m	1	630 kg







# TEREX CRANES

## Tower Cranes

Via delle Innovazioni, 17  
33074 Fontanafredda (PN)  
Italy

Ph: +39 0434 989111  
Email: info.cranes@terex.com

## Rough Terrain Cranes

Via Cassoletta, 76 - Fraz. Crespellano  
40053 Valsamoggia (BO)  
Italy

Ph: +39 051 6501011  
Email: info.cranes@terex.com

December 2019. Product specifications and prices are subject to change without notice or obligation. The photographs and/or drawings in this document are for illustrative purposes only. Refer to the appropriate Operator's Manual for instructions on the proper use of this equipment. Failure to follow the corresponding Operator's Manual when using our equipment or to otherwise act responsibly may result in serious injury or death. The only warranty applicable to our equipment is the standard written warranty applicable to the particular product and sale and Terex makes no other warranty, express or implied. Products and services listed may be trademarks, service marks or trade-names of Terex Corporation and/or its subsidiaries in the USA and other countries. All rights are reserved. Terex, the Terex Crown design and Works For You are trademarks of Terex Corporation or its subsidiaries.

Dicembre 2019. Specifiche e prezzi dei prodotti sono soggetti a modifica senza preavviso o altro obbligo. Le fotografie e i disegni in questo documento hanno esclusivamente scopo illustrativo. Consulta il Manuale dell'operatore pertinente per trovare istruzioni per l'utilizzo corretto di questo macchinario. La mancata osservanza delle istruzioni contenute nel relativo Manuale dell'operatore durante l'uso del macchinario e altri comportamenti irresponsabili possono provocare gravi lesioni, anche mortali. L'unica garanzia applicabile ai nostri macchinari è la garanzia scritta standard applicabile al particolare prodotto e alla particolare vendita e Terex è esonerata dal fornire qualsiasi altra garanzia, esplicita o implicita. I prodotti e servizi elencati possono essere dei marchi di fabbrica, marchi di servizio o nomi commerciali di Terex Corporation, e/o delle rispettive società affiliate negli Stati Uniti d'America e in molte altre nazioni. Tutti i diritti riservati. Terex, il marchio Terex Crown e Works for You sono marchi di proprietà di Terex Corporation o delle sue società affiliate.

Dezember 2019. Irrtum und Änderungen der Produktspezifikationen vorbehalten. Die in diesem Dokument enthaltenen Fotos und/oder Zeichnungen dienen rein anschaulichen Zwecken. Für den sachgemäßen Gebrauch der Maschinen ist das entsprechende Bedienerhandbuch heranzuziehen. Unsachgemäßer Umgang mit bzw. unsachgemäßer Einsatz unserer Maschinen kann zu schweren gesundheitlichen Schäden bis hin zum Tod führen. Für unsere Produkte wird ausschließlich die entsprechende, schriftlich niedergelegte Standardgarantie gewährt. Terex leistet keinerlei darüber hinausgehende Garantie, weder ausdrücklich noch stillschweigend. Die genannten Produkte und Dienstleistungen sind in den USA und anderen Ländern ggf. Marken, Dienstleistungsmarken oder Handelsnamen der Terex Corporation und/oder ihrer Tochtergesellschaften. Alle Rechte vorbehalten. Terex, das Terex Kronenlogo und Works For You sind Marken in Eigentum der Terex Corporation bzw. ihrer Tochtergesellschaften.

Décembre 2019. Les caractéristiques et prix des produits peuvent faire l'objet de modifications sans notification préalable. Les photographies ou dessins présentés dans ce document servent uniquement à des fins d'illustration. Pour connaître les instructions relatives à l'utilisation correcte de cet équipement, veuillez vous référer au manuel de l'utilisateur correspondant. Le non-respect du manuel d'utilisateur correspondant lors de l'utilisation de notre équipement ou des actes irresponsables risquent de provoquer de graves blessures, voire un décès. La seule garantie applicable à nos équipements est la garantie écrite standard applicable au produit et à la vente spécifiques. Terex ne délivre aucune autre garantie, expresse ou implicite. Les produits et les services mentionnés peuvent être des marques, des marques de service ou des appellations commerciales de Terex Corporation et/ou de ses filiales aux États-Unis et dans d'autres pays. Tous droits réservés. Terex, le design Terex Crown et Works For You sont des marques déposées de Terex Corporation ou de ses filiales.

Diciembre 2019. Las especificaciones y los precios de los productos están sujetos a cambios sin necesidad de previo aviso ni ninguna otra obligación. Las fotografías y/o dibujos de este documento tienen un fin meramente ilustrativo. Consulte el correspondiente manual de instrucciones del operario para obtener más información sobre el uso correcto de esta maquinaria. No respetar el manual del operario al utilizar la maquinaria o actuar de forma irresponsable puede provocar lesiones graves e incluso mortales. La única garantía aplicable a nuestra maquinaria es la garantía escrita estándar de cada producto y venta. Terex no amplía dicha garantía de forma expresa ni implícita. Los productos y servicios mencionados pueden ser marcas comerciales, marcas de servicio o nombres de marca de Terex Corporation o de alguna de sus filiales en Estados Unidos y otros países. Todos los derechos reservados. Terex, el diseño de la corona Terex y Works For You son marcas registradas de Terex Corporation o de sus filiales.

Dezembro 2019. Especificações e preços dos produtos sujeitos a alteração sem aviso prévio ou obrigações. As fotografias e/ou desenhos neste documento são apenas para fins ilustrativos. Consulte o respectivo Manual do Operador para instruções sobre o uso correto deste equipamento. Deixar de acompanhar o respectivo Manual do Operador ao usar o nosso equipamento ou, por qualquer outra forma, deixar de agir de maneira responsável pode resultar em lesões corporais graves ou a morte. A única garantia aplicável ao nosso equipamento é a garantia padrão por escrito correspondente ao produto específico vendido. A Terex não dá outras garantias, expressas ou implícitas. Os produtos e serviços listados podem ser marcas comerciais, marcas de serviço ou nomes-fantasia da Terex Corporation e/ou suas subsidiárias nos EUA e em outros países. Todos os direitos reservados. Terex, o desenho da Coroa Terex e a expressão Works For You são marcas comerciais da Terex Corporation ou suas subsidiárias.

декабрь 2019 г. года Технические характеристики и цены могут изменяться без предварительного уведомления и без каких-либо обязательств для производителя. Фотографии и (или) чертежи в настоящем документе служат только в качестве иллюстраций. Инструкции по надлежащей эксплуатации данного оборудования см. в соответствующем руководстве для оператора. Невыполнение указаний соответствующих руководств для оператора при эксплуатации оборудования или другие безответственные действия могут повлечь серьезные травмы или смерть. Единственной гарантией, действующей в отношении нашего оборудования, является стандартная форма письменной гарантии на данный тип оборудования и на условия его продажи. Terex не дает никаких других гарантий: ни ясно выраженных, ни подразумеваемых. Перечисленные продукты и услуги могут быть торговыми марками, знаками обслуживания или торговыми наименованиями Terex Corporation и / или ее дочерних компаний в США и других странах. Все права защищены. Terex, изображение короны Terex и Works for You являются торговыми марками, принадлежащими корпорации Terex или ее дочерним компаниям.



[www.terex.com/cranes](http://www.terex.com/cranes)

Brochure Reference: TC-DS-M-E/II/G/F/S/P/R-CTT172-8-12/19



**WORKS FOR YOU.™**